

## TUNGSTEN SMART-HEAT

A designed, cost-conscious product blending aesthetics and function



A designed, cost-conscious product range that does not sacrifice aesthetics for function.

The patented direct ignition system, never before seen on an outdoor gas radiant heater, ensures a reliable start and effective operation, even in winds of up to 8mph.

Easy pivot arm provides greater positioning versatility and heat coverage.

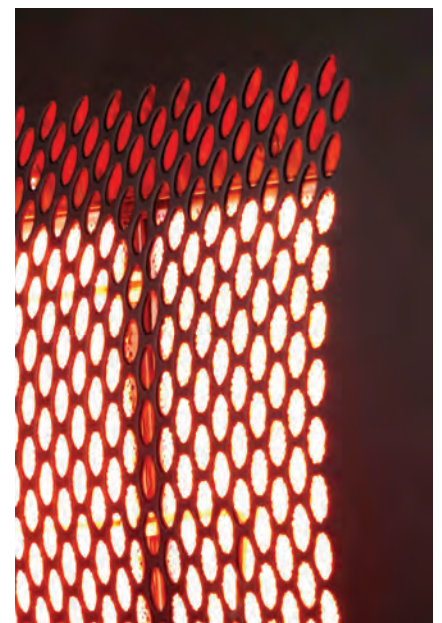
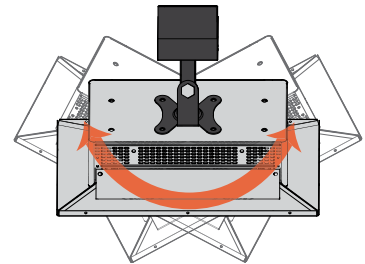

# TUNGSTEN SMART-HEAT

## FEATURES:

- Attractive black finish
- Universal bracket — easy upgrade from 300 to 500 model. No additional plumbing or wiring required.
- Bi-directional easy-pivot arm — 25° rotation each side.
- Electronic ignition — one or multiple units can be switched on and off simultaneously from a single remote-located switch.
- Automatic re-ignition — should the heater not re-ignite for any reason, the integrated “Flame Failure Safety Shut-off Control” turns the heater off immediately.
- Stainless steel casing — components are protected from tampering. Assists in preventing dirt and dust from accumulating on the wiring and components.

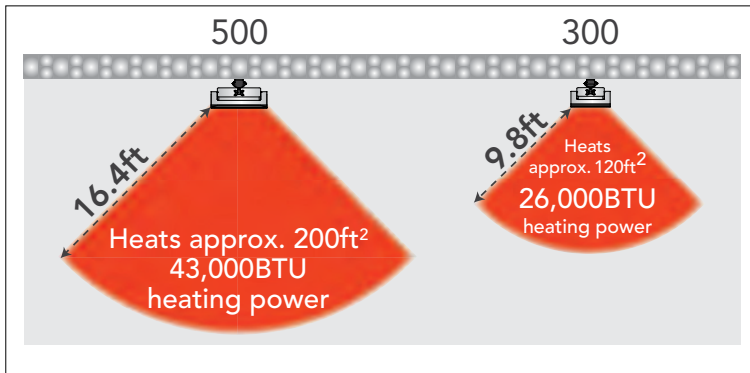
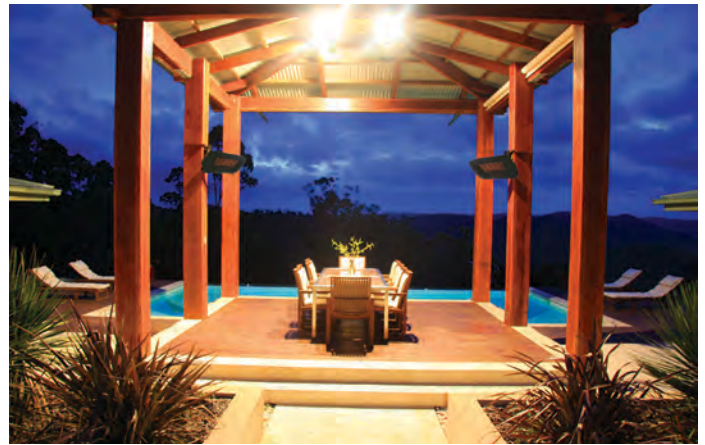

## ACCESSORIES\*

- Dual-directional ceiling pole
- Dual-layer heat deflector (See part numbers in table below)

\*all accessories sold separately

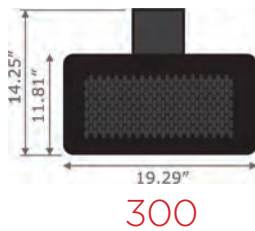
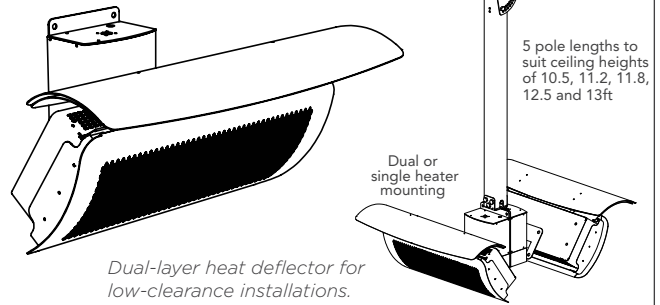

300

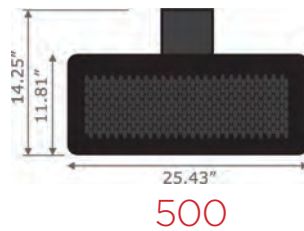

500



## SPECIFICATIONS

Model		300	500
Part no.	LPG <sup>1</sup>	BH0210002	BH0210004
	Natural Gas <sup>1</sup>	BH0210001	BH0210003
Heat Deflector part no.		BH3030001	BH3030002
Ceiling Pole		5 pole lengths to suit ceiling heights of 10.5', 11.2', 11.8', 12.5' and 13' (contact Bromic Heating for more information)	
Heat Output (on LPG and NG)		26,000BTU	43,000BTU
Approximate area heated (feet <sup>2</sup> )		up to 120ft <sup>2</sup>	up to 200ft <sup>2</sup>
Gas connection		3/8" SAE	3/8" SAE
Electrical connection		110 Volt, 3-pin insulated plug	
Dimension (WxDxH)		19.29" x 14.09" x 14.25"	25.43" x 14.09" x 14.25"
Min. distance to combustible materials (without heat deflector) <sup>2</sup>		Sides: 3.6' / 1100mm	
		Above (to ceiling): 3'6" / 1100mm	
Min. distance to combustible materials (with heat deflector)		Above (to ceiling): 12' / 1100mm	
Mounting height requirement to ground <sup>3</sup>		8' / 2438mm	8' / 2438mm
Weight (lb)		33lb	40lb

<sup>1</sup>Must only be installed by a licensed technician. Must complete "Pre-Installation Checklist" before installing. <sup>2</sup>The temperature will not exceed 65°C/149°F above the ambient temperature at specified distance. Please consult material manufacturer for temperature ratings and suitability. Bromic Heating takes no responsibility for material compliance. <sup>3</sup>8' / 2438mm or maybe lower depending on local regulations

## MINIMUM INSTALLATION CLEARANCES

